

Introduction

Sub-floor ventilation must be provided to enclosed sub-floor spaces. Moisture escapes from the soil and is absorbed by the air above, raising the relative humidity of the air. This in turn will raise the moisture content of the framing members and flooring.

Ventilation is necessary to reduce the relative humidity of the cool air in the space, by replacing air with new warm drier air drawn from outside the space. The quantity, distribution and efficiency of the vents provided is extremely important for the stability and performance of timber floors, and to reduce the risk of decay and termite hazards.

BCA Requirements

Where the sub-floor is enclosed by solid masonry (blockwork, brickwork, stone, etc), permanent vents must be installed in the masonry during construction. The BCA, Part 3.4 outlines sub-floor ventilation requirements to limit the moisture content of framing timbers in the sub-floor space. The minimum level of ventilation required to achieve this is dependent on the location and sub-floor conditions. In Queensland three climate zones apply as provided in table 1:-

Table 1 Minimum Sub-Floor Ventilation (BCA)

CLIMATE ZONE, CONDITIONS & SELECTED LOCATIONS		Min. Sub-Floor Ventilation mm ² /m of wall	
		No membrane	Ground sealed with impervious membrane
1	Inland Queensland Average 9am RH < 60%# e.g. Roma, Mt Isa	2000	1000
2	Central Queensland Average 9am RH > 60% and 3pm RH < 40%# - e.g. Dalby, Emerald	4000	2000
3	Coastal Queensland Average 9am RH > 70% and 3pm RH < 60%# e.g. Brisbane, Toowoomba, Rockhampton, Townsville, Cairns	6000	3000

Based on the maximum of the months January and July. For particular weather data refer to "Climate Averages" - www.bom.gov.au/climate/averages/tables

Requirements for T & G Floors (laid on joists or over structural sub-floors)

Timber floors should not be laid over moist sub-floor spaces as in many instances the floor will not perform satisfactorily and expansion related problems would result. Structural sub-floors, over which T & G floors may be laid, will provide some protection, however, they cannot be relied upon to prevent moisture uptake in the T & G flooring if humidities in the sub-floor space remain high for extended periods.

Timber T & G floors should therefore be provided with a minimum sub-floor ventilation that exceeds BCA requirements, and 7500 mm²/m length of wall is recommended. Furthermore, if there are doubts over the sub-floor humidity (areas of high water table, reduced airflow due to minimum clearances between the sub-floor framing and ground etc.) a polythene membrane may be laid over the soil (taped at joints and fixed to stumps and walls). This can significantly reduce moisture uptake by the sub-floor air. Increased levels of ventilation should also be considered in such instances. With dwellings on sloping blocks that have enclosed sub-floor spaces, the possibility of seepage should be taken into consideration and appropriate control measures taken prior to the installation of the floor.

Vent Installation

Distribution:

The aim of the sub-floor ventilation system is to provide cross-flow of air in both directions, ie. from side to side and end to end of the dwelling. Vents shall be placed in all walls that enclose the sub-floor space. Corresponding openings shall also be placed in any internal walls in the sub-floor space. To prevent the formation of 'dead-air' pockets in the sub-floor space, vents are to be placed within 600 mm of corners of each wall and then at the required spacing between. Vent spacing should not exceed 2000 mm. (See figure 1)

Figure 1.

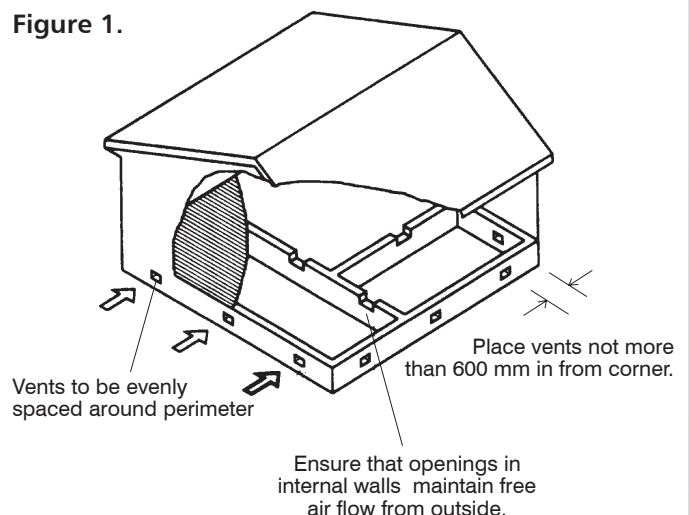

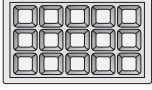

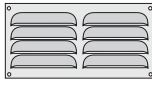
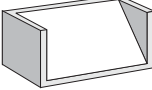

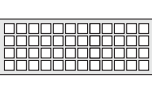



Table 2. Ventilation Provided by Commercially Available Vents

Vent Type and Specifications				Nett Ventilation Area Provided per Vent (mm ²) ⁽³⁾	Maximum Vent Spacing (mm)	
Material	Diagram	Vent Size	Vent Pattern		BCA Requirements (6000mm ² /m) No-membrane ZONE 3	T&G Flooring Requirements (7500mm ² /m)
Clay ⁽¹⁾		160 x 230	8 slots each 75 mm x 8 mm	4800	800	640
Clay ⁽¹⁾		160 x 230	15 holes each 16 mm x 16 mm	3840	640	512
Metal ⁽²⁾		200 x 400	8 slots 10 slots each 100 mm x 8 mm	5900 7400	983 1233	787 987
Metal ⁽²⁾		200 x 400	8 slots 10 slots each 175 mm x 8 mm	10700 13360	1783 2000*	1427 1781
Besser Louvre Block 15.745		200 x 400	1 slot each 320 mm x 90 mm	28800	2000*	2000*
Gradwell Cast Aluminium Air Vent		9" x 6" (230 x 160)	4 slots each 195 mm x 10 mm	7800	1300	1040
Pryda Vent Pryda Vent		230 x 75 230 x 165	52 holes 117 holes each 11 mm x 11 mm	6292 14157	1049 2360	839 1888
Pryda Slim Vent (GVS90) Pryda Slim Vent (GVS90H)		250 x 90 130 x 90	12 slots 6 slots each 110 mm x 8 mm	10560 5280	1760 880	1408 704

- Notes:
1. These clay vent products are standard 'off the shelf' items.
 2. Metal vent sizes are based upon typical products fabricated by CAIRNS HARDWARE PTY LTD to suit blockwork construction (200, 150, 100 mm thick walls).
 3. Nett ventilation area provided by each vent is an approximate value only, but is acceptable for the purpose of this note.
 4. Some concrete masonry products eg. screen blocks, may be available for use as vents, however they are not included here. * The maximum recommended vent spacing, irrespective of vent size, is 2000 mm.
 5. Where vents do not suit health regulations for vermin protection, additional screens shall be installed to ensure compliance with regulations. Enquiries should be directed to local authorities. Additional screens may reduce the effectiveness of the vents.

For other vents not listed in the table, the following formula may be used to calculate the vent spacing and required number of vents:-

- Nett ventilation area of one vent**
= The number of holes x area of each hole (mm²)
- Max. vent spacing (mm)**
= Net ventilation area of one vent (mm²) ÷ minimum ventilation requirement (mm²/m) x 1000 (mm/m)
- Required number of vents for each wall**
= Length of wall (mm) ÷ max. vent spacing (mm) and then round up to the nearest whole number.
- Actual vent spacing**
= wall length ÷ (required number of vents + 1).
Check that this does not place them more than 600 mm from a corner.

Example for vents not listed in table 2

Ensure that the 'nett ventilation area per vent' is calculated by working out the actual area of holes in a particular vent (not the overall size of the vent). E.g. a typical clay brick vent has 15 holes each 16 x 16 mm therefore the nett area of this vent is - 16 x 16 x 15 holes = 3840 mm². Remember, for pressed metal or gauze type vents the same applies - the actual area of holes must be calculated.

For timber floors the 'max. vent spacing' of clay brick vents (with nett ventilation area as above) will be 3840 mm² ÷ 7500 mm²/m x 1000 mm/m = 512 mm.

The 'number of vents required' for each length of wall is given by the length of the wall divided by the minimum vent spacing. i.e. If the clay brick vents as above were used, for a wall length of 8000 mm, the required number of vents would be 8000 mm ÷ 512 mm = 15.6 (16) vents. The actual vent spacing is 8000 mm ÷ (16+1) = 471 mm.

Ventilation efficiency:

The sub-floor space must be free from all building debris and vegetation. Obstacles that prevent air-flow to and from vents will reduce the efficiency of the sub-floor ventilation system. Landscaping should not limit air-flow around the external perimeter of the sub-floor space, and structural elements should not limit air-flow. Vents should be installed in the masonry course below floor bearers, and should not be obscured by engaged piers or piers/stumps/columns which support the floor structure, or by any services present. Where external structures (fences etc.) or landscape may reduce airflow, consideration should be given to the use of more than the minimum number of vents.

Where verandahs or decks are constructed outside the dwelling perimeter, care should be taken to ensure that the amount of ventilation provided around the verandah or deck perimeter is equivalent to or greater than the amount required for the adjacent external wall. Where ventilation is obstructed by patios etc., additional ventilation should be provided to ensure that the overall level of ventilation is maintained and cross flow is achieved.

If adequate natural ventilation cannot be provided to sub-floor spaces, a mechanical ventilation system should be installed which replaces all of the air in this space on a regular basis, and prevents the formation of 'dead-air' pockets.

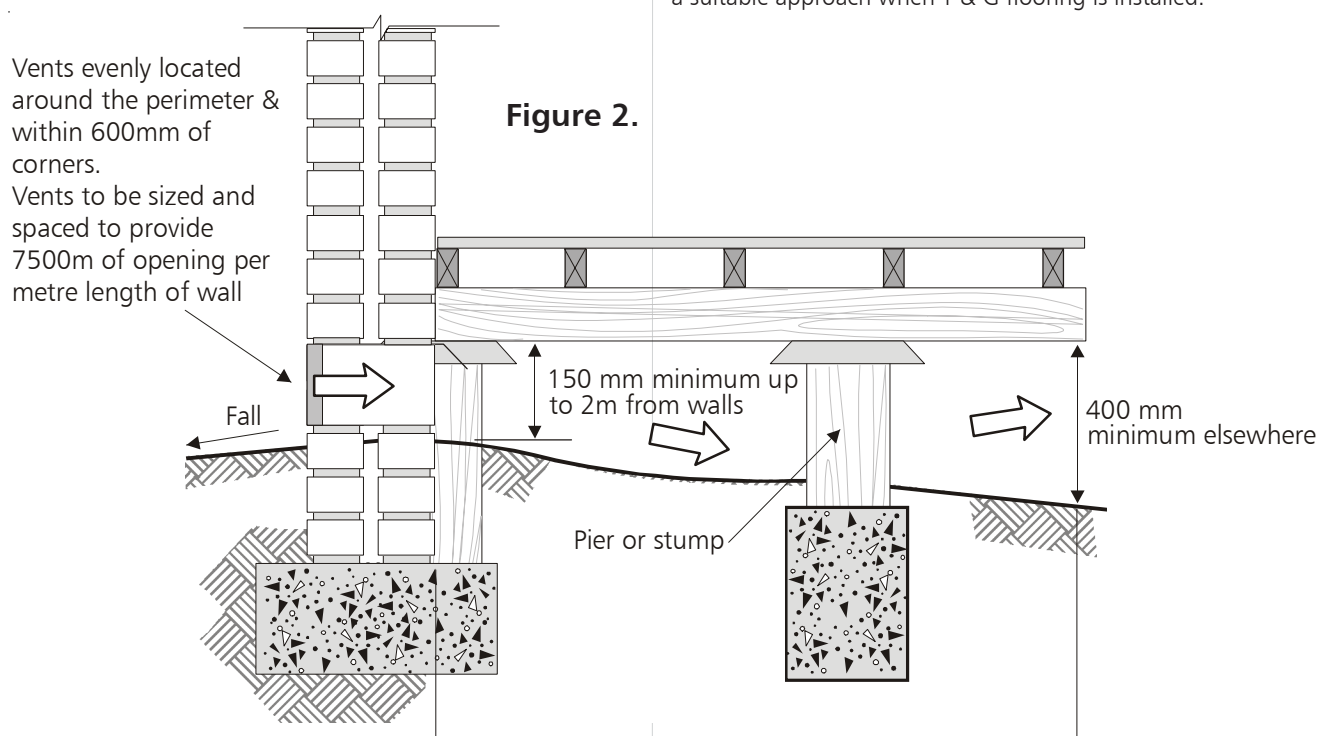

Minimum height of floor above ground (for ventilation and termite inspection access):

Access for visual inspection shall include a minimum clearance of 400 mm between finished ground level and any structural components or other obstructions, e.g. bearers, joists or plumbing fixtures. On a sloping site, the minimum clearance may be reduced to 150 mm, provided that the area is no more than 2 m from a point with conforming sub-floor clearance. (See figure 2) Where chemical termite barriers or continuous (under the whole sub-floor) physical termite barriers are provided, the minimum height to the lowest floor framing member shall be 150 mm.

Site drainage:

The drainage system provided to the dwelling site, should ensure that run-off water will drain away from the building perimeter (not towards it) and that run-off water is prevented from entering the sub-floor space. The ground beneath a suspended floor should also be graded so that no ponding is possible. Where springs or aquifers are present (e.g. exposed by earthworks on sloping sites) and cause water to enter the sub-floor space, a closed drainage system should be installed under the dwelling to remove this water. The ventilation system will not cope with this level of moisture in the space.

If continually damp environments exist under a dwelling (e.g. high water tables) the BCA states that one of the following options is necessary:-

- the sub-floor ventilation requirement must be increased by 50% or;
- an impervious membrane must be provided over the soil or;
- durability class 1 or 2 timbers or H3 preservative treated timbers (softwoods) shall be used.

These options primarily relate to the performance of the sub-floor framing, which has greater tolerance to moisture content fluctuations than T & G flooring. The use of higher durability sub-floor framing members to cope with higher moisture levels is not a suitable approach when T & G flooring is installed.



**TIMBER
QUEENSLAND**

Timber Queensland Limited
ACN 092 686 756 • ABN 50 092 686 756
500 Brunswick Street, Fortitude Valley
Brisbane Queensland 4006
PO Box 2014, Fortitude Valley BC Qld 4006

Phone: (07) 3254 1989

Fax: (07) 3254 1964

Website: www.timberqueensland.com.au

Email: admin@timberqueensland.com.au

Whilst every effort is made to ensure the accuracy of advice given, Timber Queensland Limited cannot accept liability for loss or damage arising from the use of the information supplied.